

Part Number: PT932-89180-02 (Black Chrome)

Kit Contents

Item #	Quantity Reqd.	Description
1	1	Black Stainless-Steel Exhaust Tip
2	1	Black Stainless-Steel Clamp Assembly
3	2	Aluminum Spacers

Hardware Bag Contents

Item #	Quantity Reqd.	Description
1	N/A	

Additional Items Required For Installation

Item #	Quantity Reqd.	Description

Conflicts

None

Recommended Tools

Personal & Vehicle Protection	Notes
None	
Special Tools	Notes
None	
Installation Tools	Notes
Ratchet	
Socket	15 mm deep well socket
Torque wrench	55 N-m
Rubber mallet	
Non-scratch cloth	
Metric Measuring Tape/Scale	
Special Chemicals	Notes
Glass Cleaner	Dealer installed kit
Approved Cleaner	VDC installed kit

General Applicability

MY18 and newer 4Runner Models

Recommended Sequence of Application

Item #	Accessory
1	
2	

*Mandatory

Vehicle Service Parts (may be required for reassembly)

Item #	Quantity Reqd.	Description
1		
2		
3		

Legend

 **STOP:** Damage to the vehicle may occur. Do not proceed until process has been complied with.

 **OPERATOR SAFETY:** Use caution to avoid risk of injury.

 **CAUTION:** A process that must be carefully observed in order to reduce the risk of damage to the accessory/vehicle and to ensure a quality installation.

 **TOOLS & EQUIPMENT:** Used in Figures calls out the specific tools and equipment recommended for this process.

 **REVISION MARK:** This mark highlights a change in installation with respect to previous issue.

 **SAFETY TORQUE:** This mark indicates that torque is related to safety.











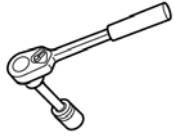

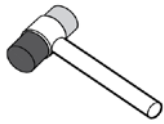

Care must be taken when installing this accessory to ensure damage does not occur to the vehicle. The installation of this accessory should follow approved guidelines to ensure a quality installation.

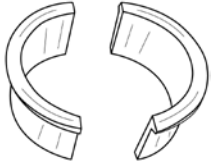
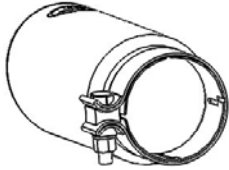
These guidelines can be found in the "Accessory Installation Practices" document.

- This document covers such items as:-
- Vehicle Protection (use of covers and blankets, cleaning chemicals, etc.).
 - Safety (eye protection, rechecking torque procedure, etc.).
 - Vehicle Disassembly/Reassembly (panel removal, part storage, etc.).
 - Electrical Component Disassembly/Reassembly (battery disconnection, connector removal, etc.).

Vehicle Images shown below are generic and may not match actual vehicle.

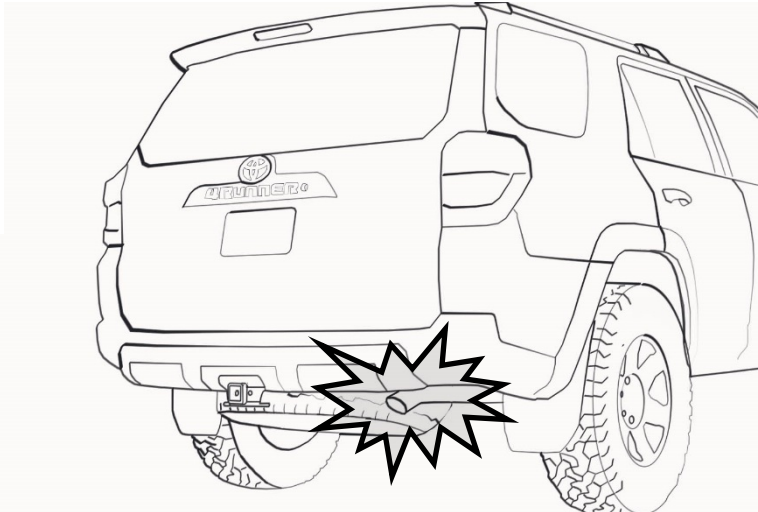
Please see your Toyota dealer for a copy of this document.

TOOLS				
 3/8" SOCKET WRENCH 15mm SOCKET	 CLEANER	 MALLET	 MEASURING SCALE	 TORQUE WRENCH (0-100 N-m)
 LINT FREE				
KIT CONTENTS				
A 	B  x2 SPACERS	C  CLAMP & EXHAUST TIP (pre-installed)		
CAUTIONS				
				
 HOT!!				
				

1

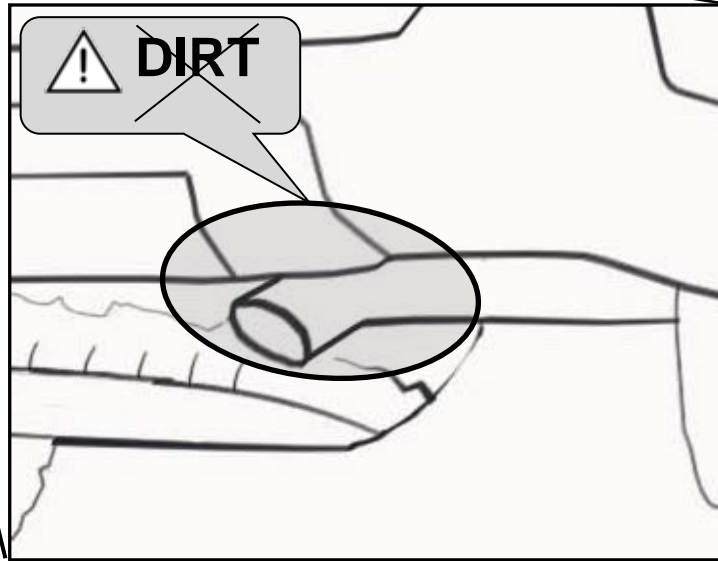
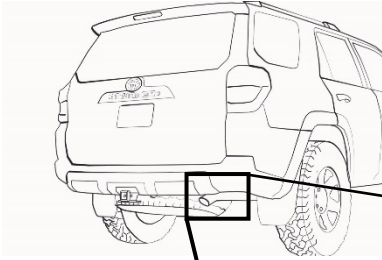

2

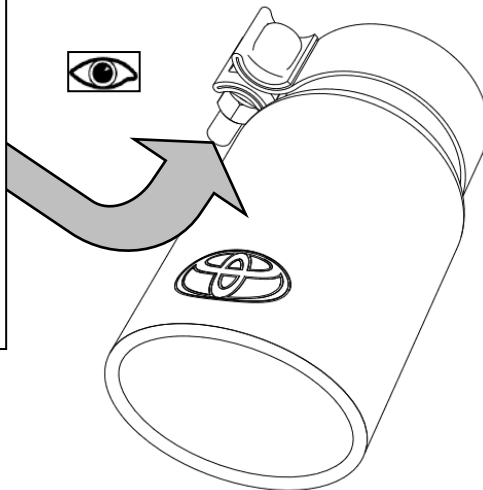
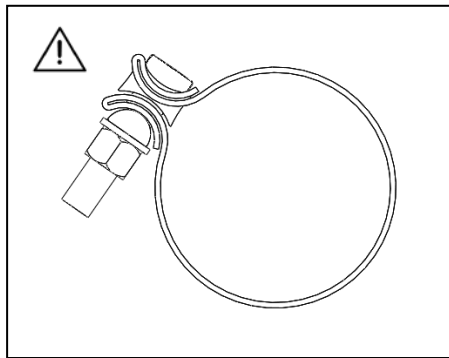

3

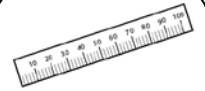
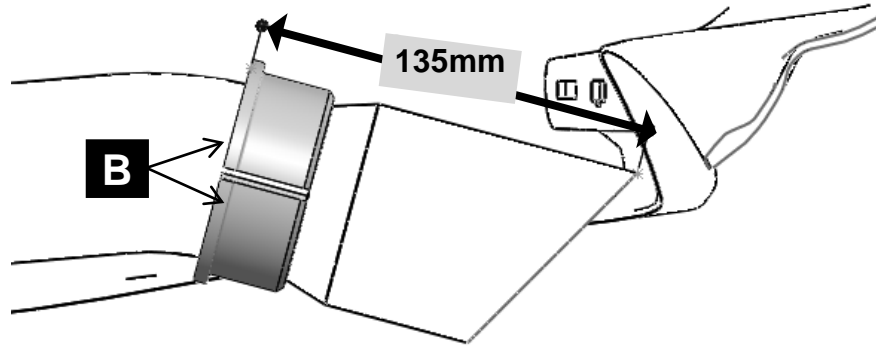

MEASURING
SCALE



x2 SPACERS

4

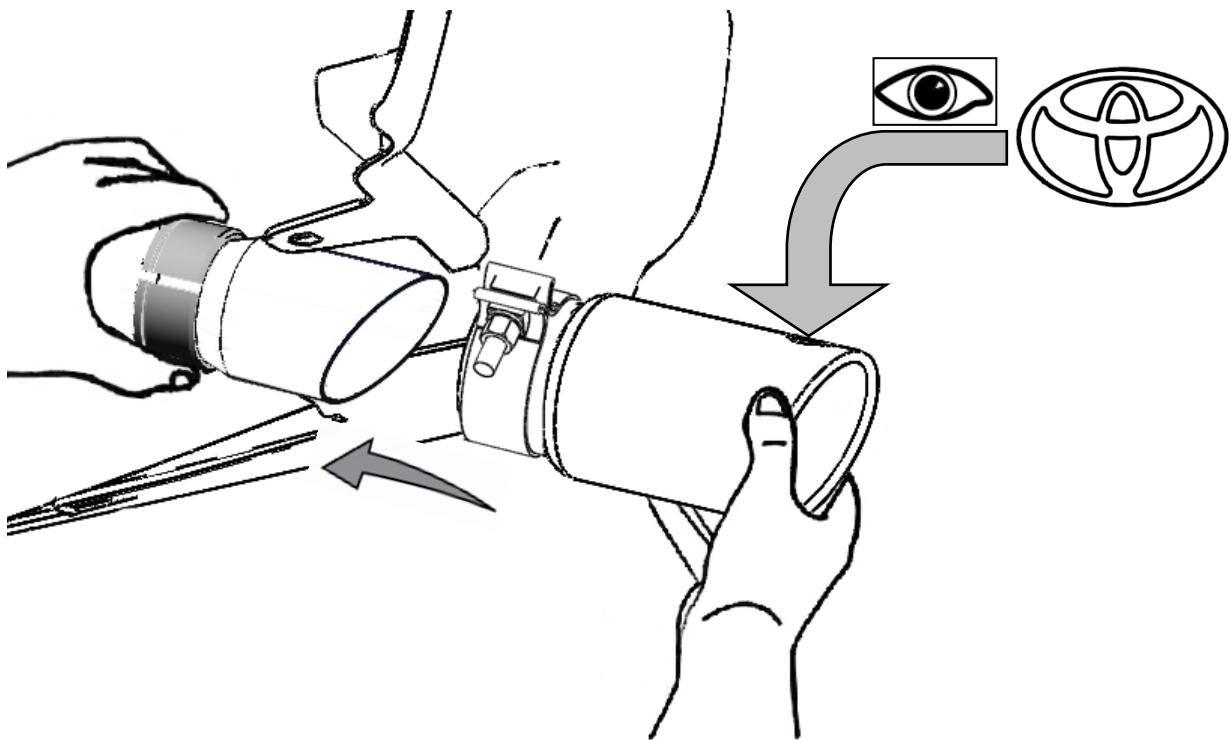

5

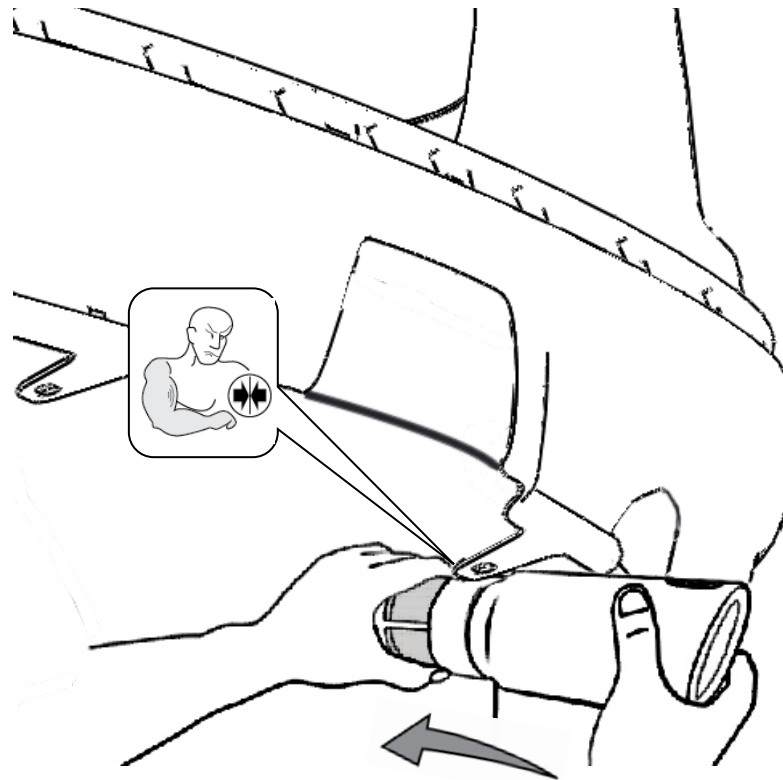

6

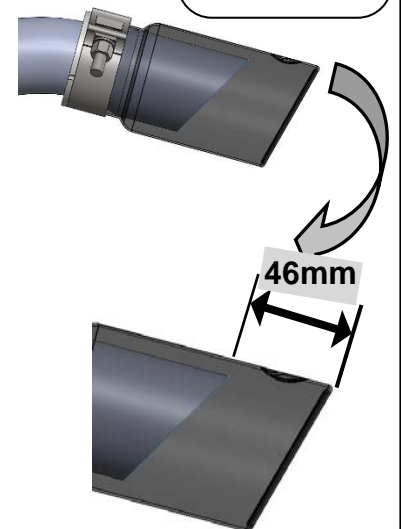
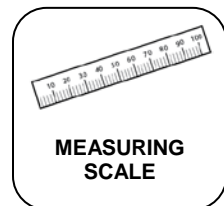
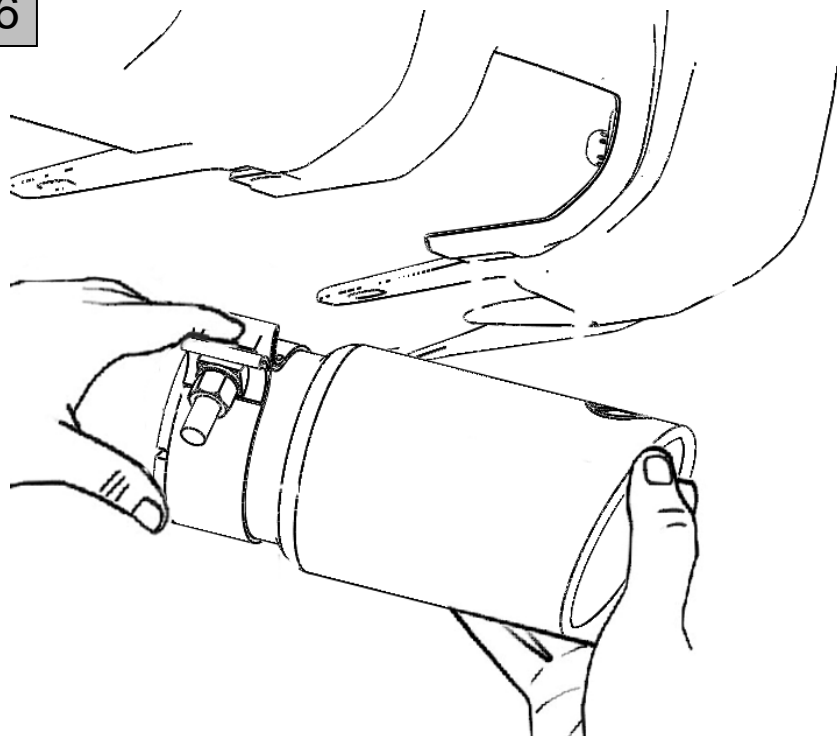

7

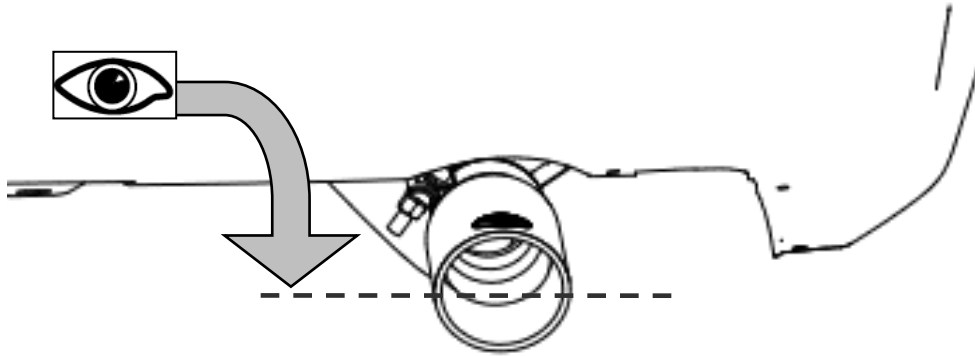

8

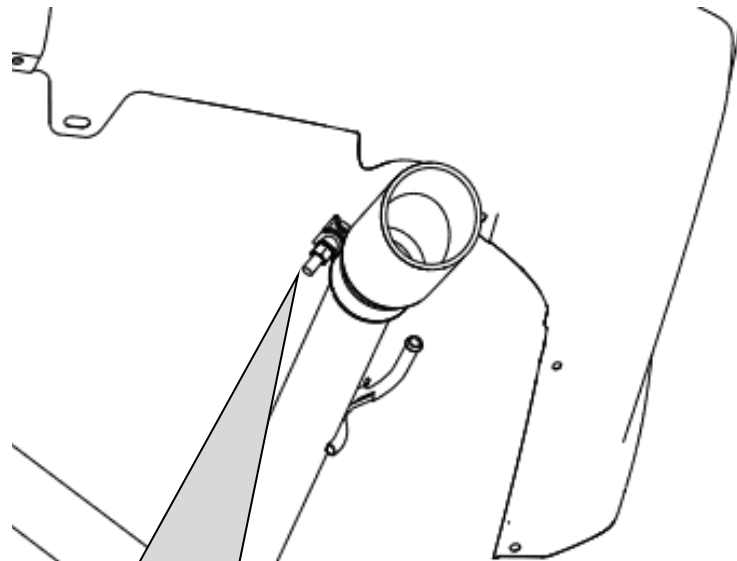

TORQUE
55Nm (40.57 Ft/lbs)

 ,WAIT 5 SEC.
TORQUE
55Nm (40 57 Ft/lbs)

TOYOTA 4RUNNER 2018 - STAINLESS STEEL EXHAUST TIP
Checklist - these points **MUST** be checked to ensure a quality installation.

<u>Check:</u>	<u>Look For:</u>
<p><u>Accessory Function Checks</u></p> <ul style="list-style-type: none"><input type="checkbox"/> Correct part number has been installed.<input type="checkbox"/> Nut torque.<input type="checkbox"/> Clamp alignment. <input type="checkbox"/> Tip alignment.	<p>Verify part number on package. Nut torque should be: 55Nm (40.57 Ft/lbs). Clamp should be oriented with bolt on the right side with the nut facing down.</p>
<p><u>Vehicle Function Checks</u></p> <ul style="list-style-type: none"><input type="checkbox"/> Rattle or vibration.	<p>Start engine and check for rattle or vibration of exhaust tip.</p>
<p><u>Vehicle Appearance Check</u></p> <ul style="list-style-type: none"><input type="checkbox"/> After accessory installation, perform a visual inspection.	<p>Ensure no damage (including scuffs and scratches) was caused during the installation process. (For PPO installations, refer to TMS Accessory Quality Shipping Standard.)</p>